

Maximum performance
to a great drilling experience



MAXPRO DRILL
2D | 3D | 4D | 5D



XCS Toolholders

Palbit's MaxPro Drill indexable drilling tool is a versatile and high-performance tool designed for drilling operations on various surfaces.

With cutting diameters ranging from $\text{\O}14\text{mm}$ to $\text{\O}50\text{mm}$ and drilling lengths from $2xDc$ to $5xDc$, the MaxPro Drill is capable of handling a wide range of drilling requirements.

Its specialized cutting inserts allow for efficient and precise drilling on flat surfaces, inclined surfaces, as well as for making crossing holes, chain drilling, and stack drilling.

Whether drilling through multiple layers of materials or working on complex drilling projects, the MaxPro Drill offers reliable performance and exceptional results.

Its modular design and quick-change inserts also help to reduce tool changeover times and increase productivity.

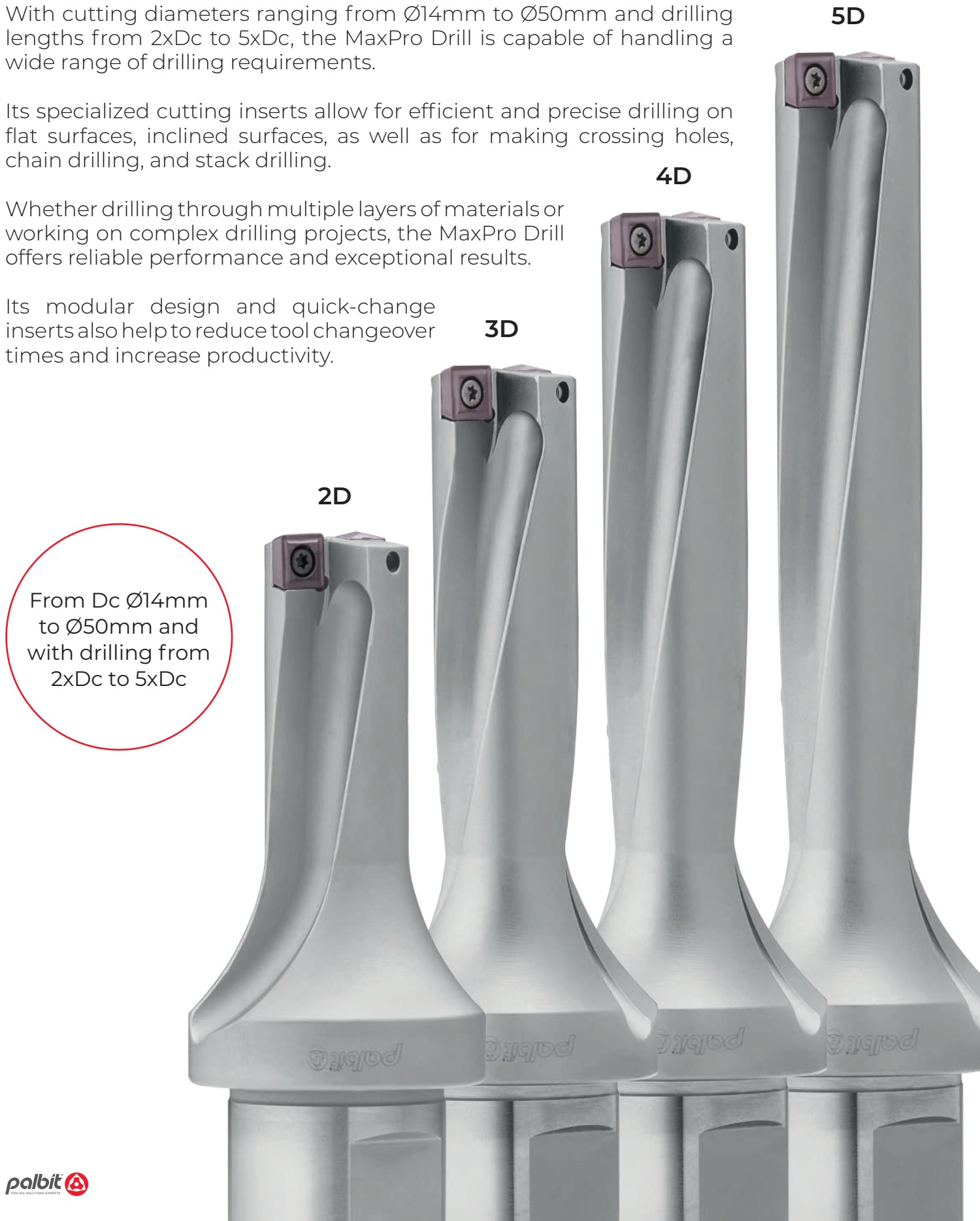

From Dc $\text{\O}14\text{mm}$
to $\text{\O}50\text{mm}$ and
with drilling from
 $2xDc$ to $5xDc$

SOKX & XOKX inserts



SOKX
Outer Insert



SOKX-MP
Outer Insert

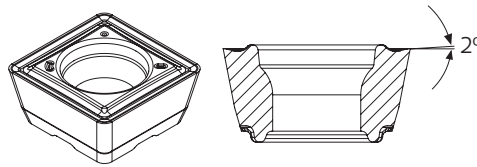

SOKX-MS
Outer Insert

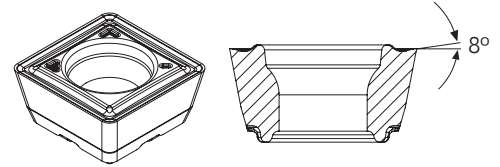

XOKX
Inner Insert



XOKX-MP
Inner Insert

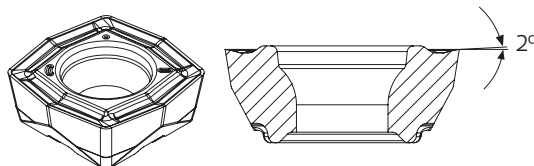

XOKX-MS
Inner Insert

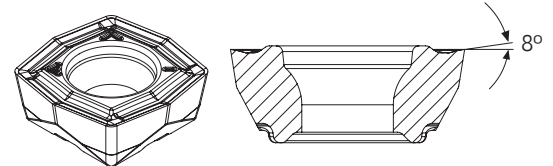

Applicability

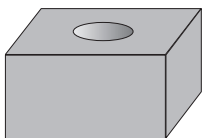

Flat Surface

MaxPro Drill is designed to perform efficient and precise drilling on flat surfaces. Its cutting inserts are carefully selected to deliver optimal performance on various materials.

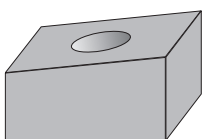

Inclined Surface

The MaxPro Drill is also suitable for drilling on inclined surfaces. Its specialized inserts can handle the cutting forces and torque required to cut through materials at different angles.

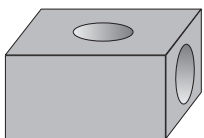

Crossing Hole

With its precise positioning and excellent stability, MaxPro Drill is ideal for making crossing holes. It allows for accurate and efficient drilling operations without compromising the quality of the finished product.

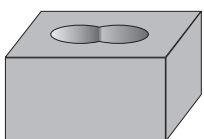

Chain Drilling

The MaxPro Drill is capable of performing chain drilling operations, thanks to its cutting-edge design and high-quality cutting inserts. It allows for faster drilling speeds and improved productivity, while also reducing tool changeover times.

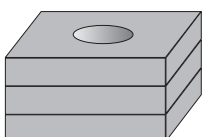

Stack Drilling

The MaxPro Drill is also well-suited for stack drilling applications. Its modular design and reliable performance make it an excellent choice for drilling multiple layers of materials with precision and ease.

XCS 2D

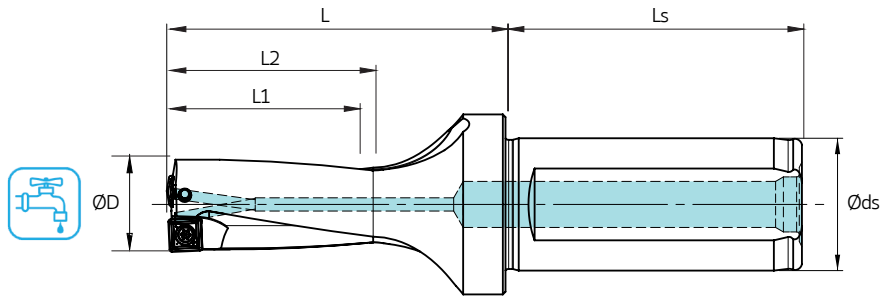

Øds	Ls	BP / SP
20	50	PT - 1/8
25	56	PT - 1/8
32	60	PT - 1/4
40	70	PT - 1/4

2D		
ØD	Drill tolerance	Hole tolerance
14-29,5	0/-0,15	-0,10/+0,20
30-42	0/-0,15	-0,10/+0,25
43-50	0/-0,15	-0,10/+0,28

Order code	Reference	Dimensions (mm)					Inner Insert	Outer Insert	Insert Screw	Torx key	Stock
		ØD	Ø ds	L1	L2	L					
184316800	XCS 14020-2D	14,00	20	28	31	51	XOKX 050204	SOKX 050204	P0200500	XT06	📦
184316900	XCS 14520-2D	14,50	20	29	32	52	XOKX 050204	SOKX 050204	P0200500	XT06	📦
184317000	XCS 15020-2D	15,00	20	30	33	53	XOKX 050204	SOKX 050204	P0200500	XT06	📦
184317100	XCS 15520-2D	15,50	20	31	34	54	XOKX 050204	SOKX 050204	P0200500	XT06	📦
184317200	XCS 16020-2D	16,00	20	32	35	55	XOKX 050204	SOKX 050204	P0200500	XT06	📦
184317300	XCS 16525-2D	16,50	25	33	36	61	XOKX 060204	SOKX 060205	P0220500	XT06	📦
184317400	XCS 17025-2D	17,00	25	34	37	62	XOKX 060204	SOKX 060205	P0220500	XT06	📦
184317500	XCS 17525-2D	17,50	25	35	38	63	XOKX 060204	SOKX 060205	P0220500	XT06	📦
184317600	XCS 18025-2D	18,00	25	36	39	64	XOKX 060204	SOKX 060205	P0220500	XT06	📦
184317700	XCS 18525-2D	18,50	25	37	40	65	XOKX 060204	SOKX 060205	P0220500	XT06	📦
184317800	XCS 19025-2D	19,00	25	38	41	66	XOKX 060204	SOKX 060205	P0220500	XT06	📦
184317900	XCS 19525-2D	19,50	25	39	42	67	XOKX 060204	SOKX 060205	P0220500	XT06	📦
184318000	XCS 20025-2D	20,00	25	40	43	68	XOKX 07T205	SOKX 07T208	P0250704	XT08	📦
184318100	XCS 20525-2D	20,50	25	41	44	69	XOKX 07T205	SOKX 07T208	P0250704	XT08	📦
184318200	XCS 21025-2D	21,00	25	42	45	70	XOKX 07T205	SOKX 07T208	P0250704	XT08	📦
184318300	XCS 21525-2D	21,50	25	43	46	71	XOKX 07T205	SOKX 07T208	P0250704	XT08	📦
184318400	XCS 22025-2D	22,00	25	44	47	72	XOKX 07T205	SOKX 07T208	P0250704	XT08	📦
184318500	XCS 22525-2D	22,50	25	45	48	73	XOKX 07T205	SOKX 07T208	P0250704	XT08	📦
184318600	XCS 23025-2D	23,00	25	46	49	74	XOKX 07T205	SOKX 07T208	P0250704	XT08	📦
184318700	XCS 23525-2D	23,50	25	47	50	75	XOKX 07T205	SOKX 07T208	P0250704	XT08	📦

📦 Stock item | Produto de stock | Itens de stock ○ Available under request | Disponível sob consulta | Disponible bajo consulta

Order code	Reference	Dimensions (mm)					Inner Insert	Outer Insert	Insert Screw	Torx key	Stock
		ØD	Ø ds	L1	L2	L					
184318800	XCS 24032-2D	24,00	32	48	51	81	XOKX 090305	SOKX 090308	P0300701	XT08	📦
184318900	XCS 24532-2D	24,50	32	49	52	82	XOKX 090305	SOKX 090308	P0300701	XT08	📦
184319000	XCS 25032-2D	25,00	32	50	53	83	XOKX 090305	SOKX 090308	P0300701	XT08	📦
184319100	XCS 25532-2D	25,50	32	51	54	84	XOKX 090305	SOKX 090308	P0300701	XT08	📦
184319200	XCS 26032-2D	26,00	32	52	55	85	XOKX 090305	SOKX 090308	P0300701	XT08	📦
184319300	XCS 26532-2D	26,50	32	53	56	86	XOKX 090305	SOKX 090308	P0300701	XT08	📦
184319400	XCS 27032-2D	27,00	32	54	57	87	XOKX 090305	SOKX 090308	P0300701	XT08	📦
184319500	XCS 27532-2D	27,50	32	55	58	88	XOKX 090305	SOKX 090308	P0300701	XT08	📦
184319600	XCS 28032-2D	28,00	32	56	59	89	XOKX 090305	SOKX 090308	P0300701	XT08	📦
184319700	XCS 28532-2D	28,50	32	57	60	90	XOKX 090305	SOKX 090308	P0300701	XT08	📦
184319800	XCS 29032-2D	29,00	32	58	61	91	XOKX 090305	SOKX 090308	P0300701	XT08	📦
184319900	XCS 29532-2D	29,50	32	59	62	92	XOKX 090305	SOKX 090308	P0300701	XT08	📦
184320000	XCS 30032-2D	30,00	32	62	65	95	XOKX 11T306	SOKX 11T308	P0350903	XT15	📦
184320100	XCS 31032-2D	31,00	32	64	67	97	XOKX 11T306	SOKX 11T308	P0350903	XT15	📦
184320200	XCS 32032-2D	32,00	32	66	69	99	XOKX 11T306	SOKX 11T308	P0350903	XT15	📦
184320300	XCS 33032-2D	33,00	32	68	71	101	XOKX 11T306	SOKX 11T308	P0350903	XT15	📦
184320400	XCS 34032-2D	34,00	32	70	73	103	XOKX 11T306	SOKX 11T308	P0350903	XT15	📦
184320500	XCS 35032-2D	35,00	32	72	75	105	XOKX 11T306	SOKX 11T308	P0350903	XT15	📦
184320600	XCS 36040-2D	36,00	40	74	77	112	XOKX 130406	SOKX 130410	P0401200	XT15	📦
184320700	XCS 37040-2D	37,00	40	76	79	114	XOKX 130406	SOKX 130410	P0401200	XT15	📦
184320800	XCS 38040-2D	38,00	40	78	81	116	XOKX 130406	SOKX 130410	P0401200	XT15	📦
184320900	XCS 39040-2D	39,00	40	80	83	118	XOKX 130406	SOKX 130410	P0401200	XT15	📦
184321000	XCS 40040-2D	40,00	40	82	85	120	XOKX 130406	SOKX 130410	P0401200	XT15	📦
184321100	XCS 41040-2D	41,00	40	84	87	122	XOKX 130406	SOKX 130410	P0401200	XT15	📦
184321200	XCS 42040-2D	42,00	40	86	89	124	XOKX 130406	SOKX 130410	P0401200	XT15	📦
184321300	XCS 43040-2D	43,00	40	88	91	126	XOKX 150508	SOKX 150510	P0501300	XT20	📦
184321400	XCS 44040-2D	44,00	40	90	93	128	XOKX 150508	SOKX 150510	P0501300	XT20	📦
184321500	XCS 45040-2D	45,00	40	92	95	130	XOKX 150508	SOKX 150510	P0501300	XT20	📦
184321600	XCS 46040-2D	46,00	40	94	97	132	XOKX 150508	SOKX 150510	P0501300	XT20	📦
184321700	XCS 47040-2D	47,00	40	96	99	134	XOKX 150508	SOKX 150510	P0501300	XT20	📦
184321800	XCS 48040-2D	48,00	40	98	101	136	XOKX 150508	SOKX 150510	P0501300	XT20	📦
184321900	XCS 49040-2D	49,00	40	100	103	138	XOKX 150508	SOKX 150510	P0501300	XT20	📦
184322000	XCS 50040-2D	50,00	40	102	105	140	XOKX 150508	SOKX 150510	P0501300	XT20	📦

📦 Stock item | Produto de stock | Itens de stock ○ Available under request | Disponível sob consulta | Disponible bajo consulta

XCS 3D

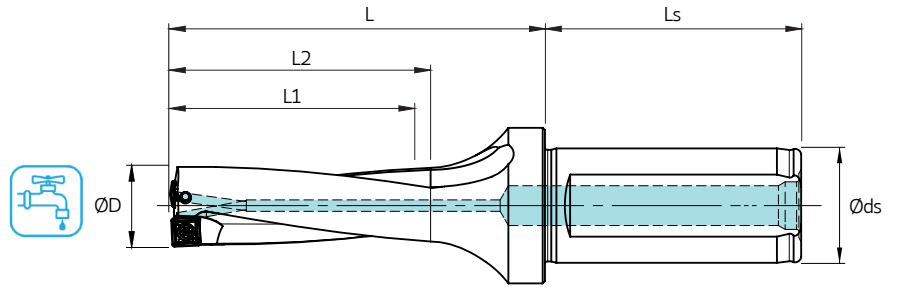

Øds	Ls	BP / SP	3D		
			ØD	Drill tolerance	Hole tolerance
20	50	PT - 1/8	14-29,5	0/-0,15	-0,10/+0,20
25	56	PT - 1/8	30-42	0/-0,15	-0,10/+0,25
32	60	PT - 1/4	43-50	0/-0,15	-0,10/+0,28
40	70	PT - 1/4			

Order code	Reference	Dimensions (mm)					Inner Insert	Outer Insert	Insert Screw	Torx key	Stock
		ØD	Ø ds	L1	L2	L					
184322100	XCS 14020-3D	14,00	20	42	45	65	XOKX 050204	SOKX 050204	P0200500	XT06	📦
184322200	XCS 14520-3D	14,50	20	44	47	67	XOKX 050204	SOKX 050204	P0200500	XT06	📦
184322300	XCS 15020-3D	15,00	20	45	48	68	XOKX 050204	SOKX 050204	P0200500	XT06	📦
184322400	XCS 15520-3D	15,50	20	47	50	70	XOKX 050204	SOKX 050204	P0200500	XT06	📦
184322500	XCS 16020-3D	16,00	20	48	51	71	XOKX 050204	SOKX 050204	P0200500	XT06	📦
184322600	XCS 16525-3D	16,50	25	50	53	78	XOKX 060204	SOKX 060205	P0220500	XT06	📦
184322700	XCS 17025-3D	17,00	25	51	54	79	XOKX 060204	SOKX 060205	P0220500	XT06	📦
184322800	XCS 17525-3D	17,50	25	53	56	81	XOKX 060204	SOKX 060205	P0220500	XT06	📦
184322900	XCS 18025-3D	18,00	25	54	57	82	XOKX 060204	SOKX 060205	P0220500	XT06	📦
184323000	XCS 18525-3D	18,50	25	56	59	84	XOKX 060204	SOKX 060205	P0220500	XT06	📦
184323100	XCS 19025-3D	19,00	25	57	60	85	XOKX 060204	SOKX 060205	P0220500	XT06	📦
184323200	XCS 19525-3D	19,50	25	59	62	87	XOKX 060204	SOKX 060205	P0220500	XT06	📦
184323300	XCS 20025-3D	20,00	25	60	63	88	XOKX 07T205	SOKX 07T208	P0250704	XT08	📦
184323400	XCS 20525-3D	20,50	25	62	65	90	XOKX 07T205	SOKX 07T208	P0250704	XT08	📦
184323500	XCS 21025-3D	21,00	25	63	66	91	XOKX 07T205	SOKX 07T208	P0250704	XT08	📦
184323600	XCS 21525-3D	21,50	25	65	68	93	XOKX 07T205	SOKX 07T208	P0250704	XT08	📦
184323700	XCS 22025-3D	22,00	25	66	69	94	XOKX 07T205	SOKX 07T208	P0250704	XT08	📦
184323800	XCS 22525-3D	22,50	25	68	71	96	XOKX 07T205	SOKX 07T208	P0250704	XT08	📦
184323900	XCS 23025-3D	23,00	25	69	72	97	XOKX 07T205	SOKX 07T208	P0250704	XT08	📦
184324000	XCS 23525-3D	23,50	25	71	74	99	XOKX 07T205	SOKX 07T208	P0250704	XT08	📦

📦 Stock item | Produto de stock | Itens de stock ○ Available under request | Disponível sob consulta | Disponible bajo consulta

Order code	Reference	Dimensions (mm)					Inner Insert	Outer Insert	Insert Screw	Torx key	Stock
		ØD	Ø ds	L1	L2	L					
184324100	XCS 24032-3D	24,00	32	72	75	105	XOKX 090305	SOKX 090308	P0300701	XT08	📦
184324200	XCS 24532-3D	24,50	32	74	77	107	XOKX 090305	SOKX 090308	P0300701	XT08	📦
184324300	XCS 25032-3D	25,00	32	75	78	108	XOKX 090305	SOKX 090308	P0300701	XT08	📦
184324400	XCS 25532-3D	25,50	32	77	80	110	XOKX 090305	SOKX 090308	P0300701	XT08	📦
184324500	XCS 26032-3D	26,00	32	78	81	111	XOKX 090305	SOKX 090308	P0300701	XT08	📦
184324600	XCS 26532-3D	26,50	32	80	83	113	XOKX 090305	SOKX 090308	P0300701	XT08	📦
184324700	XCS 27032-3D	27,00	32	81	84	114	XOKX 090305	SOKX 090308	P0300701	XT08	📦
184324800	XCS 27532-3D	27,50	32	83	86	116	XOKX 090305	SOKX 090308	P0300701	XT08	📦
184324900	XCS 28032-3D	28,00	32	84	87	117	XOKX 090305	SOKX 090308	P0300701	XT08	📦
184325000	XCS 28532-3D	28,50	32	86	89	119	XOKX 090305	SOKX 090308	P0300701	XT08	📦
184325100	XCS 29032-3D	29,00	32	87	90	120	XOKX 090305	SOKX 090308	P0300701	XT08	📦
184325200	XCS 29532-3D	29,50	32	89	92	122	XOKX 090305	SOKX 090308	P0300701	XT08	📦
184325300	XCS 30032-3D	30,00	32	92	95	125	XOKX 11T306	SOKX 11T308	P0350903	XT15	📦
184325400	XCS 31032-3D	31,00	32	95	98	128	XOKX 11T306	SOKX 11T308	P0350903	XT15	📦
184325500	XCS 32032-3D	32,00	32	98	101	131	XOKX 11T306	SOKX 11T308	P0350903	XT15	📦
184325600	XCS 33032-3D	33,00	32	101	104	134	XOKX 11T306	SOKX 11T308	P0350903	XT15	📦
184325700	XCS 34032-3D	34,00	32	104	107	137	XOKX 11T306	SOKX 11T308	P0350903	XT15	📦
184325800	XCS 35032-3D	35,00	32	107	110	140	XOKX 11T306	SOKX 11T308	P0350903	XT15	📦
184325900	XCS 36040-3D	36,00	40	110	113	148	XOKX 130406	SOKX 130410	P0401200	XT15	📦
184326000	XCS 37040-3D	37,00	40	113	116	151	XOKX 130406	SOKX 130410	P0401200	XT15	📦
184326100	XCS 38040-3D	38,00	40	116	119	154	XOKX 130406	SOKX 130410	P0401200	XT15	📦
184326200	XCS 39040-3D	39,00	40	119	122	157	XOKX 130406	SOKX 130410	P0401200	XT15	📦
184326300	XCS 40040-3D	40,00	40	122	125	160	XOKX 130406	SOKX 130410	P0401200	XT15	📦
184326400	XCS 41040-3D	41,00	40	125	128	163	XOKX 130406	SOKX 130410	P0401200	XT15	📦
184326500	XCS 42040-3D	42,00	40	128	131	166	XOKX 130406	SOKX 130410	P0401200	XT15	📦
184326600	XCS 43040-3D	43,00	40	131	134	169	XOKX 150508	SOKX 150510	P0501300	XT20	📦
184326700	XCS 44040-3D	44,00	40	134	137	172	XOKX 150508	SOKX 150510	P0501300	XT20	📦
184310700	XCS 45040-3D	45,00	40	137	140	175	XOKX 150508	SOKX 150510	P0501300	XT20	📦
184310800	XCS 46040-3D	46,00	40	140	143	178	XOKX 150508	SOKX 150510	P0501300	XT20	📦
184322100	XCS 47040-3D	47,00	40	143	146	181	XOKX 150508	SOKX 150510	P0501300	XT20	📦
184322200	XCS 48040-3D	48,00	40	146	149	184	XOKX 150508	SOKX 150510	P0501300	XT20	📦
184322300	XCS 49040-3D	49,00	40	149	152	187	XOKX 150508	SOKX 150510	P0501300	XT20	📦
184322400	XCS 50040-3D	50,00	40	152	155	190	XOKX 150508	SOKX 150510	P0501300	XT20	📦

📦 Stock item | Produto de stock | Itens de stock ○ Available under request | Disponível sob consulta | Disponible bajo consulta

XCS 4D

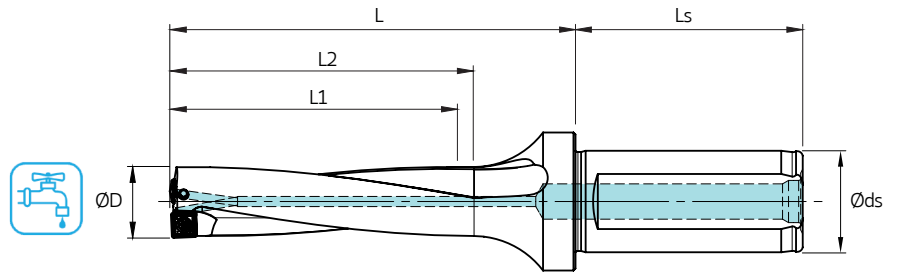

$\varnothing ds$	Ls	BP / SP	4D		
			$\varnothing D$	Drill tolerance	Hole tolerance
20	50	PT - 1/8	14-29,5	0/-0,15	-0,05/+0,25
25	56	PT - 1/8	30-42	0/-0,15	-0,05/+0,30
32	60	PT - 1/4	43-50	0/-0,15	-0,05/+0,33
40	70	PT - 1/4			

Order code	Reference	Dimensions (mm)					Inner Insert	Outer Insert	Insert Screw	Torx key	Stock
		$\varnothing D$	$\varnothing ds$	L1	L2	L					
184327200	XCS 14020-4D	14,00	20	56	59	79	XOKX 050204	SOKX 050204	P0200500	XT06	📦
184327300	XCS 14520-4D	14,50	20	58	61	81	XOKX 050204	SOKX 050204	P0200500	XT06	📦
184327400	XCS 15020-4D	15,00	20	60	63	83	XOKX 050204	SOKX 050204	P0200500	XT06	📦
184327500	XCS 15520-4D	15,50	20	62	65	85	XOKX 050204	SOKX 050204	P0200500	XT06	📦
184327600	XCS 16020-4D	16,00	20	64	67	87	XOKX 050204	SOKX 050204	P0200500	XT06	📦
184327700	XCS 16525-4D	16,50	25	66	69	94	XOKX 060204	SOKX 060205	P0220500	XT06	📦
184327800	XCS 17025-4D	17,00	25	68	71	96	XOKX 060204	SOKX 060205	P0220500	XT06	📦
184327900	XCS 17525-4D	17,50	25	70	73	98	XOKX 060204	SOKX 060205	P0220500	XT06	📦
184328000	XCS 18025-4D	18,00	25	72	75	100	XOKX 060204	SOKX 060205	P0220500	XT06	📦
184328100	XCS 18525-4D	18,50	25	74	77	102	XOKX 060204	SOKX 060205	P0220500	XT06	📦
184328200	XCS 19025-4D	19,00	25	76	79	104	XOKX 060204	SOKX 060205	P0220500	XT06	📦
184328300	XCS 19525-4D	19,50	25	78	81	106	XOKX 060204	SOKX 060205	P0220500	XT06	📦
184328400	XCS 20025-4D	20,00	25	80	83	108	XOKX 07T205	SOKX 07T208	P0250704	XT08	📦
184328500	XCS 20525-4D	20,50	25	82	85	110	XOKX 07T205	SOKX 07T208	P0250704	XT08	📦
184328600	XCS 21025-4D	21,00	25	84	87	112	XOKX 07T205	SOKX 07T208	P0250704	XT08	📦
184328700	XCS 21525-4D	21,50	25	86	89	114	XOKX 07T205	SOKX 07T208	P0250704	XT08	📦
184328800	XCS 22025-4D	22,00	25	88	91	116	XOKX 07T205	SOKX 07T208	P0250704	XT08	📦
184328900	XCS 22525-4D	22,50	25	90	93	118	XOKX 07T205	SOKX 07T208	P0250704	XT08	📦
184329000	XCS 23025-4D	23,00	25	92	95	120	XOKX 07T205	SOKX 07T208	P0250704	XT08	📦
184329100	XCS 23525-4D	23,50	25	94	97	122	XOKX 07T205	SOKX 07T208	P0250704	XT08	📦

📦 Stock item | Produto de stock | Itens de stock ○ Available under request | Disponível sob consulta | Disponible bajo consulta

Order code	Reference	Dimensions (mm)					Inner Insert	Outer Insert	Insert Screw	Torx key	Stock
		ØD	Ø ds	L1	L2	L					
184329200	XCS 24032-4D	24,00	32	96	99	129	XOKX 090305	SOKX 090308	P0300701	XT08	📦
184329300	XCS 24532-4D	24,50	32	98	101	131	XOKX 090305	SOKX 090308	P0300701	XT08	📦
184329400	XCS 25032-4D	25,00	32	100	103	133	XOKX 090305	SOKX 090308	P0300701	XT08	📦
184329500	XCS 25532-4D	25,50	32	102	105	135	XOKX 090305	SOKX 090308	P0300701	XT08	📦
184329600	XCS 26032-4D	26,00	32	104	107	137	XOKX 090305	SOKX 090308	P0300701	XT08	📦
184329700	XCS 26532-4D	26,50	32	106	109	139	XOKX 090305	SOKX 090308	P0300701	XT08	📦
184329800	XCS 27032-4D	27,00	32	108	111	141	XOKX 090305	SOKX 090308	P0300701	XT08	📦
184329900	XCS 27532-4D	27,50	32	110	113	143	XOKX 090305	SOKX 090308	P0300701	XT08	📦
184330000	XCS 28032-4D	28,00	32	112	115	145	XOKX 090305	SOKX 090308	P0300701	XT08	📦
184330100	XCS 28532-4D	28,50	32	114	117	147	XOKX 090305	SOKX 090308	P0300701	XT08	📦
184330200	XCS 29032-4D	29,00	32	116	119	149	XOKX 090305	SOKX 090308	P0300701	XT08	📦
184330300	XCS 29532-4D	29,50	32	118	121	151	XOKX 090305	SOKX 090308	P0300701	XT08	📦
184330400	XCS 30032-4D	30,00	32	122	125	155	XOKX 11T306	SOKX 11T308	P0350903	XT15	📦
184330500	XCS 31032-4D	31,00	32	126	129	159	XOKX 11T306	SOKX 11T308	P0350903	XT15	📦
184330600	XCS 32032-4D	32,00	32	130	133	163	XOKX 11T306	SOKX 11T308	P0350903	XT15	📦
184330700	XCS 33032-4D	33,00	32	134	137	167	XOKX 11T306	SOKX 11T308	P0350903	XT15	📦
184330800	XCS 34032-4D	34,00	32	138	141	171	XOKX 11T306	SOKX 11T308	P0350903	XT15	📦
184330900	XCS 35032-4D	35,00	32	142	145	175	XOKX 11T306	SOKX 11T308	P0350903	XT15	📦
184331000	XCS 36040-4D	36,00	40	146	149	184	XOKX 130406	SOKX 130410	P0401200	XT15	📦
184331100	XCS 37040-4D	37,00	40	150	153	188	XOKX 130406	SOKX 130410	P0401200	XT15	📦
184331200	XCS 38040-4D	38,00	40	154	157	192	XOKX 130406	SOKX 130410	P0401200	XT15	📦
184331300	XCS 39040-4D	39,00	40	158	161	196	XOKX 130406	SOKX 130410	P0401200	XT15	📦
184331400	XCS 40040-4D	40,00	40	162	165	200	XOKX 130406	SOKX 130410	P0401200	XT15	📦
184331500	XCS 41040-4D	41,00	40	166	169	204	XOKX 130406	SOKX 130410	P0401200	XT15	📦
184331600	XCS 42040-4D	42,00	40	170	173	208	XOKX 130406	SOKX 130410	P0401200	XT15	📦
184331700	XCS 43040-4D	43,00	40	174	177	212	XOKX 150508	SOKX 150510	P0501300	XT20	📦
184331800	XCS 44040-4D	44,00	40	178	181	216	XOKX 150508	SOKX 150510	P0501300	XT20	📦
184331900	XCS 45040-4D	45,00	40	182	185	220	XOKX 150508	SOKX 150510	P0501300	XT20	📦
184332000	XCS 46040-4D	46,00	40	186	189	224	XOKX 150508	SOKX 150510	P0501300	XT20	📦
184332100	XCS 47040-4D	47,00	40	190	193	228	XOKX 150508	SOKX 150510	P0501300	XT20	📦
184332200	XCS 48040-4D	48,00	40	194	197	232	XOKX 150508	SOKX 150510	P0501300	XT20	📦
184332300	XCS 49040-4D	49,00	40	198	201	236	XOKX 150508	SOKX 150510	P0501300	XT20	📦
184332400	XCS 50040-4D	50,00	40	202	205	240	XOKX 150508	SOKX 150510	P0501300	XT20	📦

📦 Stock item | Produto de stock | Itens de stock ○ Available under request | Disponível sob consulta | Disponible bajo consulta

XCS 5D

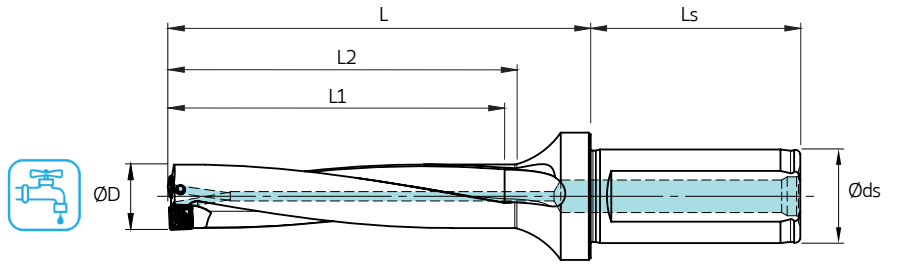

Øds	Ls	BP / SP
20	50	PT - 1/8
25	56	PT - 1/8
32	60	PT - 1/4
40	70	PT - 1/4

5D		
ØD	Drill tolerance	Hole tolerance
14-29,5	0/-0,15	-0,05/+0,25
30-42	0/-0,15	-0,05/+0,30
43-50	0/-0,15	-0,05/+0,33

Order code	Reference	Dimensions (mm)					Inner Insert	Outer Insert	Insert Screw	Torx key	Stock
		ØD	Ø ds	L1	L2	L					
184332500	XCS 14020-5D	14,00	20	70	73	88	XOKX 050204	SOKX 050204	P0200500	XT06	📦
184332600	XCS 14520-5D	14,50	20	73	76	91	XOKX 050204	SOKX 050204	P0200500	XT06	📦
184332700	XCS 15020-5D	15,00	20	75	78	93	XOKX 050204	SOKX 050204	P0200500	XT06	📦
184332800	XCS 15520-5D	15,50	20	78	81	96	XOKX 050204	SOKX 050204	P0200500	XT06	📦
184332900	XCS 16020-5D	16,00	20	80	83	98	XOKX 050204	SOKX 050204	P0200500	XT06	📦
184333000	XCS 16525-5D	16,50	25	83	86	106	XOKX 060204	SOKX 060205	P0220500	XT06	📦
184333100	XCS 17025-5D	17,00	25	85	88	108	XOKX 060204	SOKX 060205	P0220500	XT06	📦
184333200	XCS 17525-5D	17,50	25	88	91	111	XOKX 060204	SOKX 060205	P0220500	XT06	📦
184333300	XCS 18025-5D	18,00	25	90	93	113	XOKX 060204	SOKX 060205	P0220500	XT06	📦
184333400	XCS 18525-5D	18,50	25	93	96	116	XOKX 060204	SOKX 060205	P0220500	XT06	📦
184333500	XCS 19025-5D	19,00	25	95	98	118	XOKX 060204	SOKX 060205	P0220500	XT06	📦
184333600	XCS 19525-5D	19,50	25	98	101	121	XOKX 060204	SOKX 060205	P0220500	XT06	📦
184333700	XCS 20025-5D	20,00	25	100	103	123	XOKX 07T205	SOKX 07T208	P0250704	XT08	📦
184333800	XCS 20525-5D	20,50	25	103	106	126	XOKX 07T205	SOKX 07T208	P0250704	XT08	📦
184333900	XCS 21025-5D	21,00	25	105	108	128	XOKX 07T205	SOKX 07T208	P0250704	XT08	📦
184334000	XCS 21525-5D	21,50	25	108	111	131	XOKX 07T205	SOKX 07T208	P0250704	XT08	📦
184334100	XCS 22025-5D	22,00	25	110	113	133	XOKX 07T205	SOKX 07T208	P0250704	XT08	📦
184334200	XCS 22525-5D	22,50	25	113	116	136	XOKX 07T205	SOKX 07T208	P0250704	XT08	📦
184334300	XCS 23025-5D	23,00	25	115	118	138	XOKX 07T205	SOKX 07T208	P0250704	XT08	📦
184334400	XCS 23525-5D	23,50	25	118	121	141	XOKX 07T205	SOKX 07T208	P0250704	XT08	📦

📦 Stock item | Produto de stock | Itens de stock ○ Available under request | Disponível sob consulta | Disponible bajo consulta

Order code	Reference	Dimensions (mm)					Inner Insert	Outer Insert	Insert Screw	Torx key	Stock
		ØD	Ø ds	L1	L2	L					
184334500	XCS 24032-5D	24,00	32	120	123	148	XOKX 090305	SOKX 090308	P0300701	XT08	📦
184334600	XCS 24532-5D	24,50	32	123	126	151	XOKX 090305	SOKX 090308	P0300701	XT08	📦
184334700	XCS 25032-5D	25,00	32	125	128	153	XOKX 090305	SOKX 090308	P0300701	XT08	📦
184334800	XCS 25532-5D	25,50	32	128	131	156	XOKX 090305	SOKX 090308	P0300701	XT08	📦
184334900	XCS 26032-5D	26,00	32	130	133	158	XOKX 090305	SOKX 090308	P0300701	XT08	📦
184335000	XCS 26532-5D	26,50	32	133	136	161	XOKX 090305	SOKX 090308	P0300701	XT08	📦
184335100	XCS 27032-5D	27,00	32	135	138	163	XOKX 090305	SOKX 090308	P0300701	XT08	📦
184335200	XCS 27532-5D	27,50	32	138	141	176	XOKX 090305	SOKX 090308	P0300701	XT08	📦
184335300	XCS 28032-5D	28,00	32	140	143	168	XOKX 090305	SOKX 090308	P0300701	XT08	📦
184335400	XCS 28532-5D	28,50	32	143	146	171	XOKX 090305	SOKX 090308	P0300701	XT08	📦
184335500	XCS 29032-5D	29,00	32	145	148	173	XOKX 090305	SOKX 090308	P0300701	XT08	📦
184335600	XCS 29532-5D	29,50	32	148	151	176	XOKX 090305	SOKX 090308	P0300701	XT08	📦
184335700	XCS 30032-5D	30,00	32	152	155	180	XOKX 11T306	SOKX 11T308	P0350903	XT15	📦
184335800	XCS 31032-5D	31,00	32	157	160	185	XOKX 11T306	SOKX 11T308	P0350903	XT15	📦
184335900	XCS 32032-5D	32,00	32	162	165	190	XOKX 11T306	SOKX 11T308	P0350903	XT15	📦
184336000	XCS 33032-5D	33,00	32	167	170	195	XOKX 11T306	SOKX 11T308	P0350903	XT15	📦
184336100	XCS 34032-5D	34,00	32	172	175	200	XOKX 11T306	SOKX 11T308	P0350903	XT15	📦
184336200	XCS 35032-5D	35,00	32	177	180	205	XOKX 11T306	SOKX 11T308	P0350903	XT15	📦
184336300	XCS 36040-5D	36,00	40	182	185	215	XOKX 130406	SOKX 130410	P0401200	XT15	📦
184336400	XCS 37040-5D	37,00	40	187	190	220	XOKX 130406	SOKX 130410	P0401200	XT15	📦
184336500	XCS 38040-5D	38,00	40	192	195	225	XOKX 130406	SOKX 130410	P0401200	XT15	📦
184336600	XCS 39040-5D	39,00	40	197	200	230	XOKX 130406	SOKX 130410	P0401200	XT15	📦
184336700	XCS 40040-5D	40,00	40	202	205	235	XOKX 130406	SOKX 130410	P0401200	XT15	📦
184336800	XCS 41040-5D	41,00	40	207	210	240	XOKX 130406	SOKX 130410	P0401200	XT15	📦
184336900	XCS 42040-5D	42,00	40	212	215	245	XOKX 130406	SOKX 130410	P0401200	XT15	📦
184337000	XCS 43040-5D	43,00	40	217	220	250	XOKX 150508	SOKX 150510	P0501300	XT20	📦
184337100	XCS 44040-5D	44,00	40	222	225	255	XOKX 150508	SOKX 150510	P0501300	XT20	📦
184337200	XCS 45040-5D	45,00	40	227	230	260	XOKX 150508	SOKX 150510	P0501300	XT20	📦
184337300	XCS 46040-5D	46,00	40	232	235	265	XOKX 150508	SOKX 150510	P0501300	XT20	📦
184337400	XCS 47040-5D	47,00	40	237	240	270	XOKX 150508	SOKX 150510	P0501300	XT20	📦
184337500	XCS 48040-5D	48,00	40	242	245	275	XOKX 150508	SOKX 150510	P0501300	XT20	📦
184337600	XCS 49040-5D	49,00	40	247	250	280	XOKX 150508	SOKX 150510	P0501300	XT20	📦
184337700	XCS 50040-5D	50,00	40	252	255	285	XOKX 150508	SOKX 150510	P0501300	XT20	📦

📦 Stock item | Produto de stock | Itens de stock ○ Available under request | Disponível sob consulta | Disponible bajo consulta

Inserts

SOKX Outer Insert

SOKX-MP



SOKX-MS

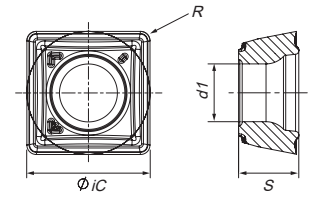

(1) Geometry code	(2) Grade code	P			M		K			S		Dimensions (mm)			
		PVD		CVD	PVD		PVD		CVD	PVD					
		T1	P4	2C	Y3	X9	T1	P4	2C	Y3	X9	iC	S	d1	R
1142113	SOKX 050204-MP	⊗		⊗					⊗			5,10	2,50	2,40	0,40
1142115	SOKX 060205-MP	⊗		⊗					⊗			6,20	2,60	2,60	0,50
1142117	SOKX 07T208-MP	⊗		⊗					⊗			7,50	2,90	2,90	0,80
1142119	SOKX 090308-MP	⊗		⊗					⊗			9,20	3,50	3,50	0,80
1142121	SOKX 11T308-MP	⊗		⊗					⊗			11,00	4,20	4,10	0,80
1142123	SOKX 130410-MP	⊗		⊗					⊗			13,00	4,73	4,60	1,00
1142125	SOKX 150510-MP	⊗		⊗					⊗			15,20	5,30	5,60	1,00
1142127	SOKX 050204-MS				⊗					⊗		5,10	2,50	2,40	0,40
1142129	SOKX 060205-MS				⊗					⊗		6,20	2,60	2,60	0,50
1142131	SOKX 07T208-MS				⊗					⊗		7,50	2,90	2,90	0,80
1142133	SOKX 090308-MS				⊗					⊗		9,20	3,50	3,50	0,80
1142135	SOKX 11T308-MS				⊗					⊗		11,00	4,20	4,10	0,80
1142137	SOKX 130410-MS				⊗					⊗		13,00	4,73	4,60	1,00
1142139	SOKX 150510-MS				⊗					⊗		15,20	5,30	5,60	1,00

⊗ Stock item | Produto de stock | Itens de stock ○ Available under request | Disponível sob consulta | Disponible bajo consulta

Insert order code = (1) Geometry code + (2) Grade code

XOKX Inner Insert

XOKX-MP



XOKX-MS

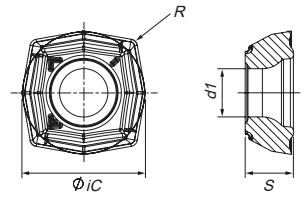

(1) Geometry code	(2) Grade code	P		M		K		S		Dimensions (mm)			
		PVD		PVD		PVD		PVD					
		T1	P4	Y3	X9	T1	P4	Y3	X9	iC	S	dI	R
1142112	XOKX 050204-MP	PHP920	PHP930							5,40	2,50	2,40	0,40
1142114	XOKX 060204-MP		PHP930							6,56	2,50	2,60	0,40
1142116	XOKX 07T205-MP		PHP930							7,80	2,90	2,90	0,50
1142118	XOKX 090305-MP		PHP930							9,60	3,50	3,50	0,50
1142120	XOKX 11T306-MP		PHP930							11,38	4,15	4,10	0,60
1142122	XOKX 130406-MP		PHP930							13,60	4,68	4,60	0,60
1142124	XOKX 150508-MP		PHP930							15,90	5,30	5,60	0,80
1142126	XOKX 050204-MS				PHH930					5,40	2,50	2,40	0,40
1142128	XOKX 060204-MS				PHH930					6,60	2,60	2,60	0,40
1142130	XOKX 07T205-MS				PHH930					7,80	2,90	2,90	0,50
1142132	XOKX 090305-MS				PHH930					9,60	3,50	3,50	0,50
1142134	XOKX 11T306-MS				PHH930					11,38	4,20	4,10	0,60
1142136	XOKX 130406-MS				PHH930					13,60	4,68	4,60	0,60
1142138	XOKX 150508-MS				PHH930					15,90	5,30	5,60	0,80

⊗ Stock item | Produto de stock | Itens de stock ○ Available under request | Disponível sob consulta | Disponible bajo consulta

Insert order code = (1) Geometry code + (2) Grade code

Spare Parts



Order Code	Reference	Torque (Nm)
290031400	P0200500	0,4
290030600	P0220500	0,8
290031300	P0250704	0,8
290030800	P0300701	1,2
290030900	P0350903	3
290047500	P0401200	3
290031700	P0501300	5

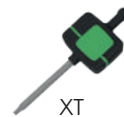

XT

Order Code	Reference
290011400	XT06
290012900	XT07
290011700	XT08
290012400	XT15
290013200	XT20

Cutting Conditions

ISO	Material Group	Vc (m/min)	fn (mm/rev)				
			Ø14~Ø16	Ø16,5~Ø23,5	Ø24~Ø29,5	Ø30~Ø42	Ø43~Ø50
P	UNALLOYED STEEL (-0,25%)	160-250	0,04-0,08	0,04-0,08	0,04-0,10	0,05-0,12	0,05-0,14
	LOW-ALLOY STEEL (0,25%-)	140-220	0,04-0,10	0,04-0,12	0,05-0,015	0,08-0,18	0,10-0,20
	LOW-ALLOY STEEL	120-220	0,04-0,10	0,05-0,10	0,05-0,12	0,06-0,18	0,06-0,20
	HIGH-ALLOY STEEL	120-180	0,04-0,12	0,05-0,12	0,07-0,16	0,08-0,18	0,08-0,20
M	STAINLESS STEEL	130-220	0,04-0,10	0,04-0,12	0,05-0,14	0,06-0,16	0,06-0,18
K	GREY CAST IRON	150-250	0,04-0,10	0,05-0,14	0,05-0,17	0,08-0,20	0,08-0,25
	CAST IRON WITH NODULAR CAST	100-200	0,04-0,12	0,04-0,12	0,05-0,14	0,06-0,15	0,06-0,18
S	SUPER-ALLOYS AND TITANIUM	30-90	0,04-0,08	0,04-0,08	0,04-0,11	0,07-0,12	0,08-0,15

NOTES

When working on irregular surfaces, please reduce the feed rate by 30%-50%. To ensure the best performance, make sure to use the proper oil pressure (over 5kg/cm²) and follow the cutting data parameters.

Power requirements

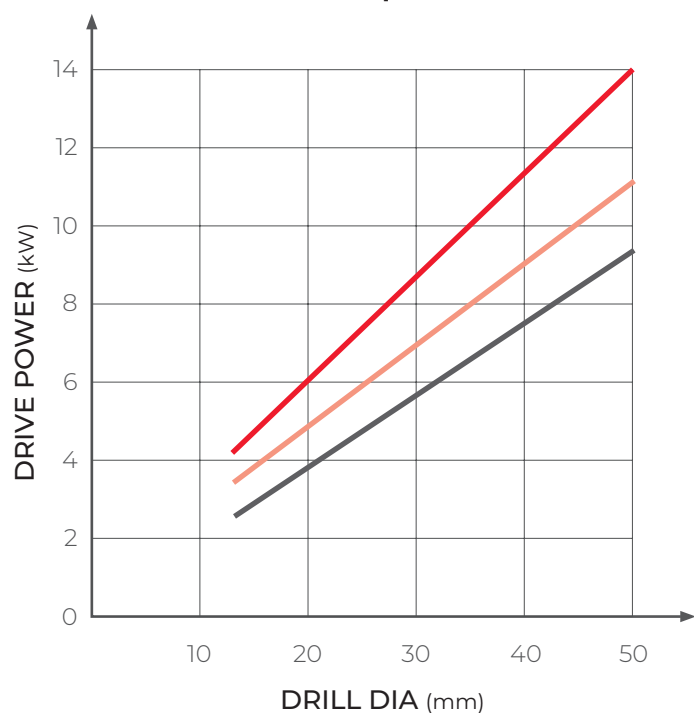

- F = 0,13 mm/r
- F = 0,10 mm/r
- F = 0,07 mm/r

Cutting oil quantity

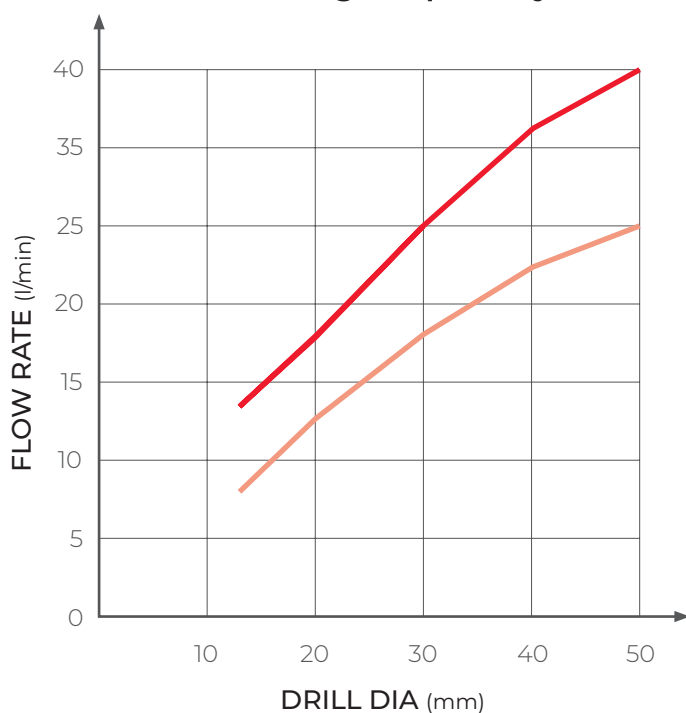

- Recommended cutting oil quantity
- Min. cutting oil quantity

NOTES

Minimum pressure coolant: 5bar

Test Report

Toolholder	Inserts	Workpiece	Cutting Conditions	Collant
XCS 17525-4D	SOKX 060205-MP PHS130; XOKX 060204-MP PHP930;	40 CrMnNiMo 8-6-4	Vc = 180m/min; fn = 0,11mm/rev; Drill depth = 65 mm;	Emulsion

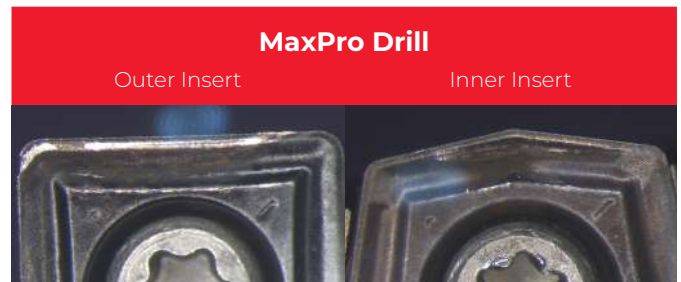
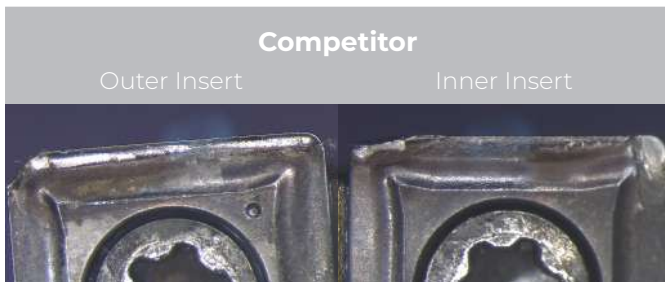
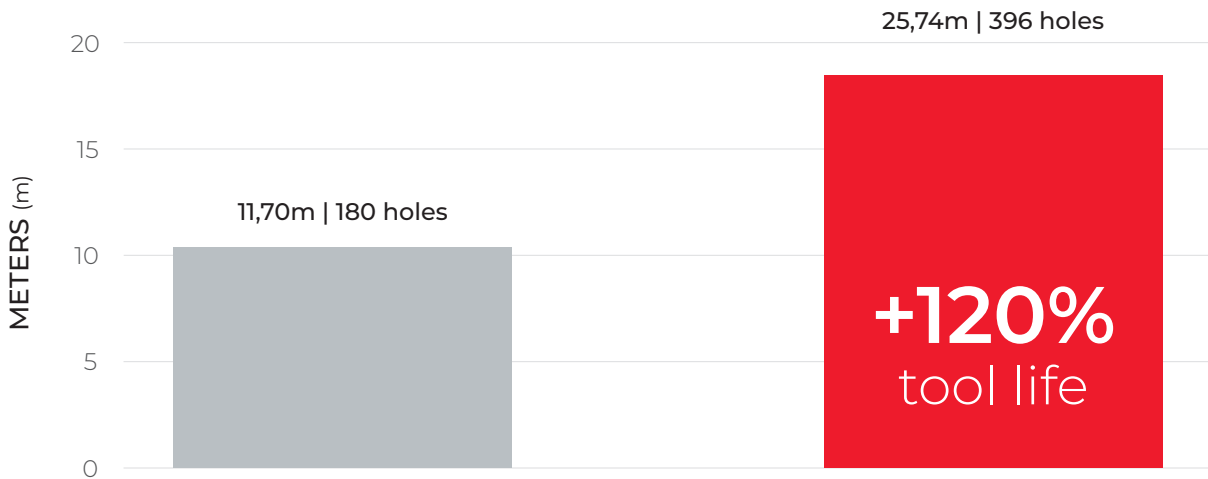

Vibrations Comparison

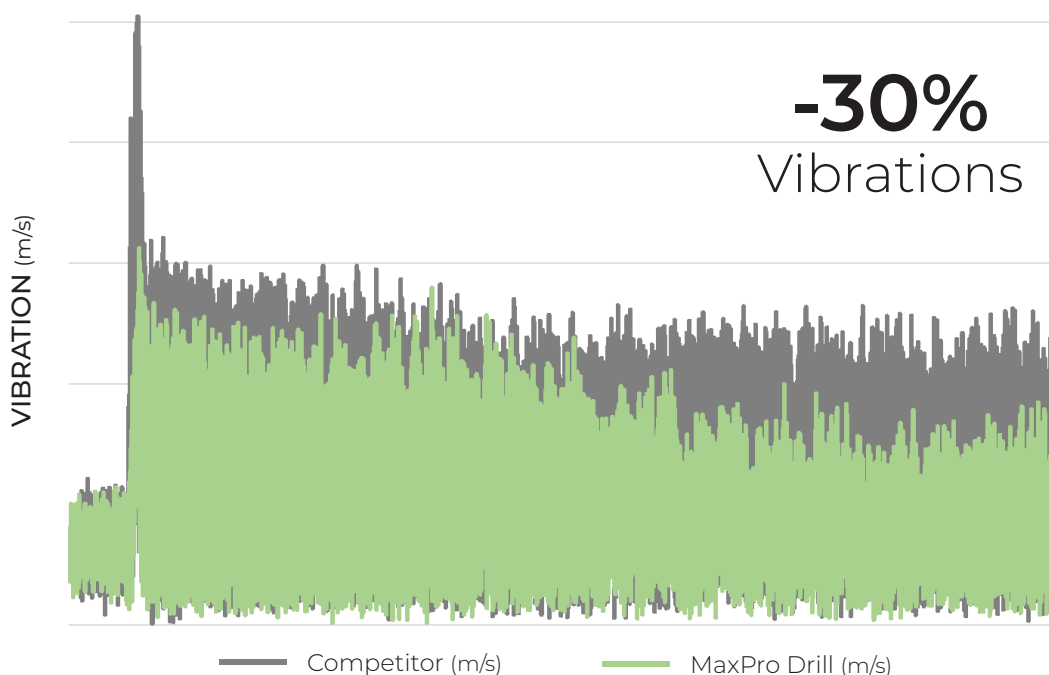

Technical Data

Grade Selection Inner Insert

PVD

Due to the reduced cutting speed in the central area of the drill, a tougher grade is recommended for the inner insert.

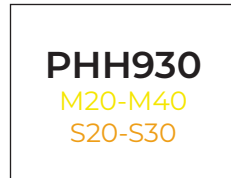

Grade Selection Outer Insert

PVD

First choice for stable machining and improved surface finish. Recommended for outer edge if chattering occurs.

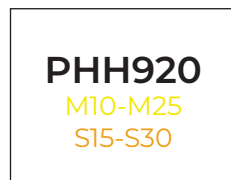
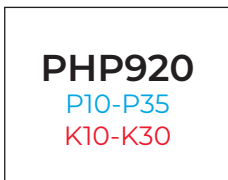

CVD

First choice for high speeds and high efficiency machining, abrasion resistance and longer tool life.

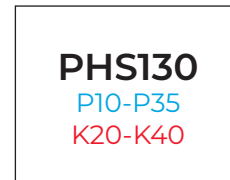

Technical information for lathe applications

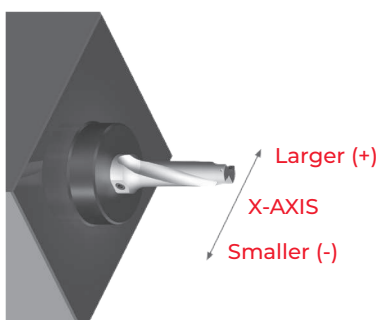

The cutting edge of insert should be parallel to X-axis to make it possible to do offset cutting. Since a flat part on shank for side lock clamping has been made parallel with the cutting edge line of insert, operator can set the drill as per flat part of shank.

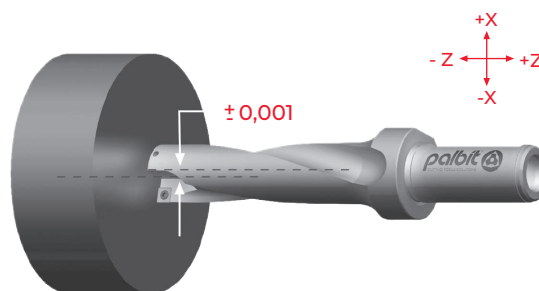

The outer insert should be located in the direction (+) of X-axis to allow offset cutting and then the inner insert should face the operator.

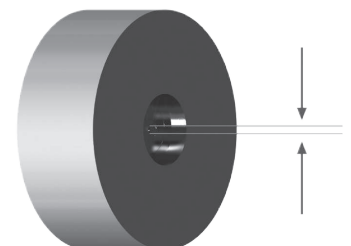

To check up the setting of drill before use, test it by drilling about 5mm depth and then measure the core size if it is around 0,2mm - 0,7mm.

WARNING

In the course of through-hole operations, a slug or disc is formed as the tool breaks through the workpiece. When the drill is stationary while the workpiece is rotating, centrifugal force may eject this slug from the chuck. It is essential to have appropriate shielding in position to ensure the safety of bystanders.

Radial Adjustment

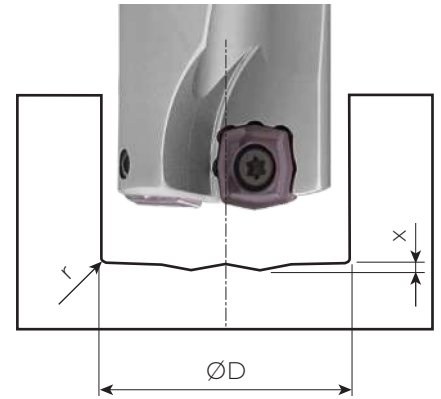

Drill diameter (Ø)	Diameter range (Ø)	Drill diameter (Ø)	Diameter range (Ø)	Drill diameter (Ø)	Diameter range (Ø)
Ø14,0	13,6~14,5	Ø26,5	25,9~27,1	Ø39,0	38,3~39,7
Ø14,5	14,1~15,0	Ø27,0	26,4~27,6	Ø39,5	38,8~40,2
Ø15,0	14,6~15,5	Ø27,5	26,9~28,1	Ø40,0	39,3~40,7
Ø15,5	15,1~16,0	Ø28,0	27,4~28,6	Ø40,5	39,8~41,2
Ø16,0	15,6~16,5	Ø28,5	27,9~29,1	Ø41,0	40,3~41,7
Ø16,5	16,0~17,0	Ø29,0	28,4~29,6	Ø41,5	40,8~42,2
Ø17,0	16,5~17,5	Ø29,5	28,9~30,1	Ø42,0	41,3~42,7
Ø17,5	17,0~18,0	Ø30,0	29,3~30,7	Ø42,5	41,8~43,2
Ø18,0	17,5~18,5	Ø30,5	29,8~31,2	Ø43,0	42,2~43,7
Ø18,5	18,0~19,0	Ø31,0	30,3~31,7	Ø43,5	42,7~44,2
Ø19,0	18,5~19,5	Ø31,5	30,8~32,2	Ø44,0	43,2~44,7
Ø19,5	19,0~20,0	Ø32,0	31,3~32,7	Ø44,5	43,7~45,2
Ø20,0	19,4~20,6	Ø32,5	31,8~33,2	Ø45,0	44,2~45,7
Ø20,5	19,9~21,1	Ø33,0	32,3~33,7	Ø45,5	44,7~46,2
Ø21,0	20,4~21,6	Ø33,5	32,8~34,2	Ø46,0	45,2~46,7
Ø21,5	20,9~22,1	Ø34,0	33,3~34,7	Ø46,5	45,7~47,2
Ø22,0	21,4~22,6	Ø34,5	33,8~35,2	Ø47,0	46,2~47,7
Ø22,5	21,9~23,1	Ø35,0	34,3~35,7	Ø47,5	46,7~48,2
Ø23,0	22,4~23,6	Ø35,5	34,8~36,2	Ø48,0	47,2~48,7
Ø23,5	22,9~24,1	Ø36,0	35,3~36,7	Ø48,5	47,7~49,2
Ø24,0	23,4~24,6	Ø36,5	35,8~37,2	Ø49,0	48,2~49,7
Ø24,5	23,9~25,1	Ø37,0	36,3~37,7	Ø49,5	48,7~50,2
Ø25,0	24,4~25,6	Ø37,5	36,8~38,2	Ø50,0	49,2~50,7
Ø25,5	24,9~26,1	Ø38,0	37,3~38,7		
Ø26,0	25,4~26,6	Ø38,5	37,8~39,2		

Bottom of blind hole



Drill diameter (mm)	Outer insert	Inner insert	x	r
Ø14,0-16,0	SOXK 050204	XOKX 050204	0,4	0,4
Ø16,5-19,5	SOXK 060205	XOKX 060205	0,5	0,5
Ø20,0-24,0	SOXK 07T208	XOKX 07T208	0,5	0,8
Ø24,5-30,0	SOXK 090308	XOKX 090308	0,7	0,8
Ø31,0-35,0	SOXK 11T308	XOKX 11T308	0,8	0,8
Ø36,0-42,0	SOXK 130410	XOKX 130410	1,0	1,0
Ø43,0-50,0	SOXK 15M510	XOKX 15M510	1,1	1,0

Troubleshooting

Failure	Solution
 <p>Chattering</p>	<ul style="list-style-type: none"> • Reduce the cutting speed and feed rate; • Ensure stable clamping; • Set the drill overhang; • Verify the machine torque;
 <p>Poor chip evacuation</p>	<ul style="list-style-type: none"> • If long chip: Increase the cutting speed and feed rate. • If short chip: Reduce the cutting speed and feed rate, and increase the coolant pressure.
 <p>Poor surface quality</p>	<ul style="list-style-type: none"> • Establish the cutting condition for improved chip control; • Reduce the feed rates or increase the cutting speed; • Increase the coolant flow and verify the coolant evacuation; • Shorten the overhang of the drill and ensure a more stable clamping;
 <p>Excessive wear or chipping</p>	<ul style="list-style-type: none"> • Verify the cutting condition; • Increase the coolant flow and verify the coolant evacuation; • Shorten the overhang of the drill and ensure a more stable clamping; • Consider changing the insert grade;

Rules & Tips

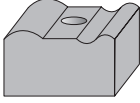
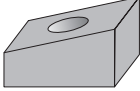
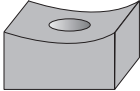
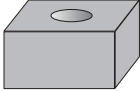
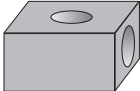
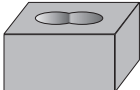
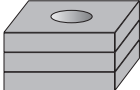
Workpiece	Machining
 Irregular surface	<ul style="list-style-type: none">· Decrease the feed by 25%;· Potential chipping and fracture;
 Inclined surface	<ul style="list-style-type: none">· Decrease the feed by 50%.
 Convex / Concave surface	<ul style="list-style-type: none">· Decrease the feed by 50% until both inserts are engaged;· Potential initial contact with the central insert identified (convex surface);
 Boring	<ul style="list-style-type: none">· Decrease the feed by 50%.
 Crossing holes	<ul style="list-style-type: none">· Decrease the feed by 50% in the overlapped section.
 Chain drilling	<ul style="list-style-type: none">· Decrease the feed by 50%.
 Stack drilling	<ul style="list-style-type: none">· Decrease the feed by 25%;· Potential chipping and fracture;



MAXPRO DRILL

2D | 3D | 4D | 5D

HEADQUARTERS

PALBIT, S.A.

P.O.Box 4 - Palhal

3854-908 - Branca ALB - Portugal

T (+351) 234 540 300 | F (+351) 234 540 301

palbit@palbit.pt | www.palbit.pt

Branch office:

PALBIT México, S de RL de CV

C/ Alfonso Esparza Oteo 37

Colonia Guadalupe Inn

Alcaldía Álvaro Obregón

01020 Ciudad de México

T (+52) 5555 454 543 | F (+52) 5552 509 190

info@palbit.com.mx | www.palbit.com/mx

Branch office:

PALBIT Brasil

Av. João XXIII, nº20 Salas 41 e 65

Vila Gilda, Sto André, SP

CEP: 09190-500 – São Paulo

T (+55) 011 25 343 648

palbit@palbit.com.br | www.palbit.com/br

